



3 GHz N LATCHING S.P.D.T. SWITCH

OPTIONS: INDICATOR / TTL DRIVE

R F CHARACTERISTICS

FREQUENCY RANGE : 0 - 3 GHz
 IMPEDANCE : 50 Ohms

FREQUENCY (GHz)	0 - 1	1 - 2	2 - 3
V.S.W.R <=	1.15	1.20	1.25
INSERT. LOSS <=	0.15 dB	0.20 dB	0.25 dB
ISOLATION >=	85 dB	80 dB	75 dB
AVER. POWER (*)	700 W	500 W	400 W

ELECTRICAL CHARACTERISTICS

ACTUATOR : LATCHING
 NOMINAL CURRENT AT 25° C (±10%) : 320 mA
 ACTUATOR VOLTAGE (Vcc) : 12V (10.2 to 13V) /NEGATIVE COMMON
 TERMINALS : male D-sub 9 pins (4-40 UNC nuts)
 INDICATOR RATING : 1 W / 30 V / 100 mA
 TTL INPUTS (E) - High level : 2.2 to 5.5V / 800µA at 5V
 - Low level : 0 to 0.8V / 20µA at 0.8V

MECHANICAL CHARACTERISTICS

CONNECTORS : N fem. per MIL C 39012
 LIFE : 1.000.000 cycles
 SWITCHING TIME (nominal voltage;25° C) : < 15 ms
 CONSTRUCTION : splashproof
 WEIGHT : < 185 g

ENVIRONMENTAL CHARACTERISTICS

OPERATING TEMPERATURE RANGE (°C) : -40 , +85
 STORAGE TEMPERATURE RANGE (°C) : -55 , +85

(* : average power at 25° C)

4112-9212 This information is given as an indication. In the continual goal to improve our products, we reserve the right to make any modifications judged necessary

DRAWING

General tolerance: * 0,5 mm

issue

Page
2/2

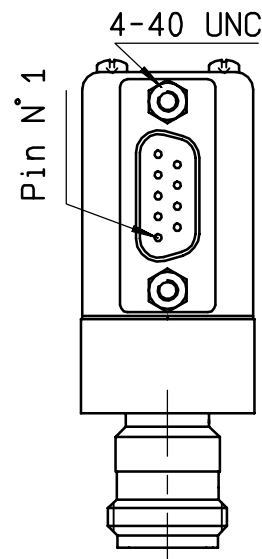
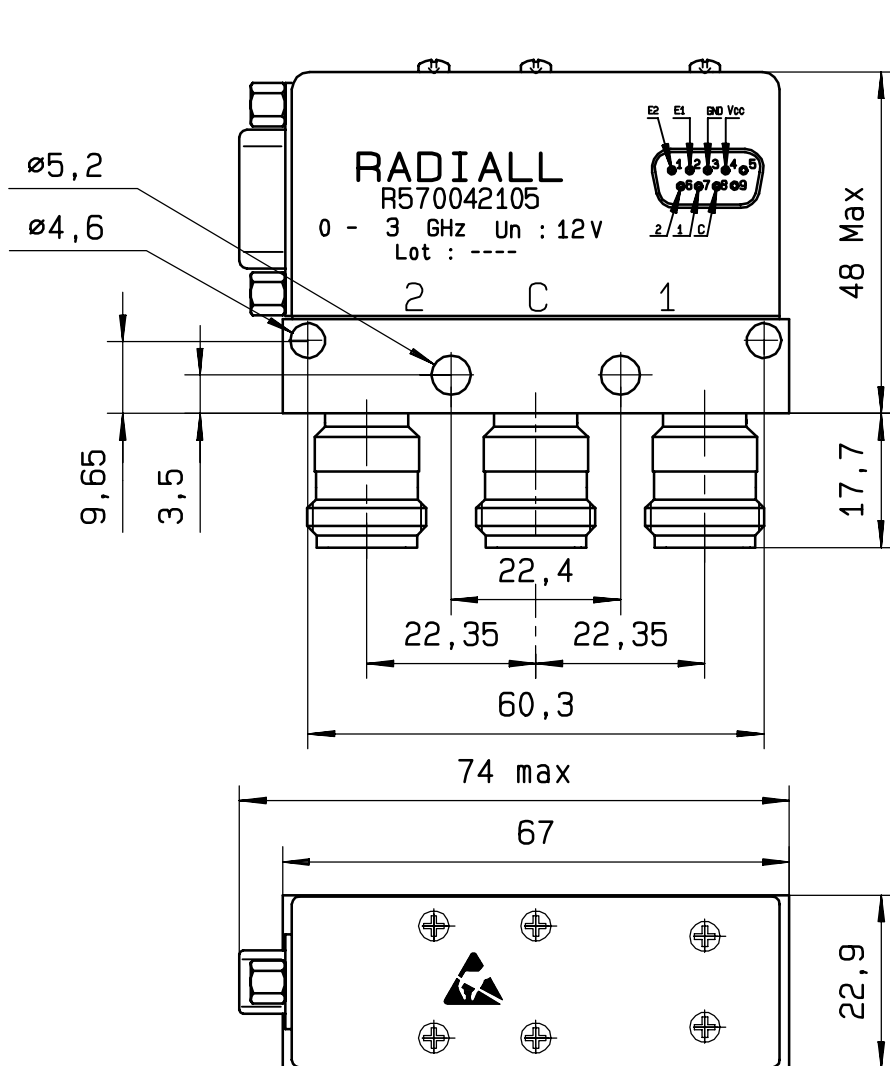

D-SUB 9 pins
bottom view

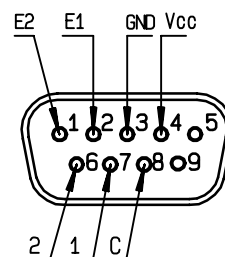

SCHEMATIC DIAGRAM

TTL input	RF continuity	Indicator
E1=1 E2=0	C ↔ 1	C . 1
E1=0 E2=1	C ↔ 2	C . 2
E1=0 E2=0	Memory	—
E1=1 E2=1	Forbidden	—

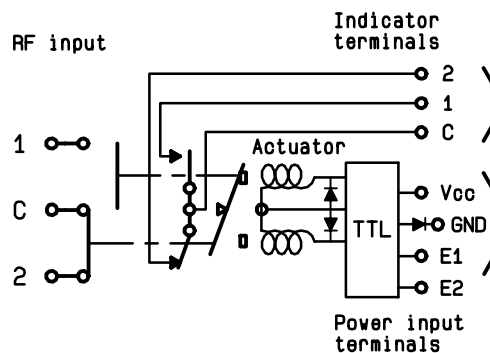

4113-9212 This information is given as an indication. In the continual goal to improve our products, we reserve the right to make any modifications judged necessary